

JVC



VIDEO CD PLAYER

影音光碟機

XL-FV323TN

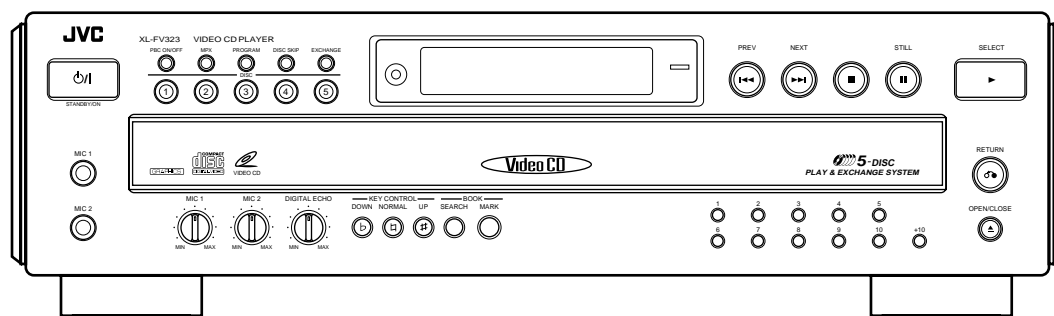
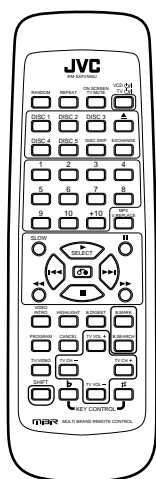

PlayBack
Control

Video CD

COMPACT
disc
DIGITAL VIDEO

COMPACT
disc
DIGITAL AUDIO
GRAPHICS

COMPACT
disc
DIGITAL AUDIO

INSTRUCTIONS

使用說明書

For Customer Use:

Enter below the Model No. and Serial No. which are located either on the rear, bottom or side of the cabinet. Retain this information for future reference.

Model No.

Serial No.

LVT0126-001A
[U, US, UF]

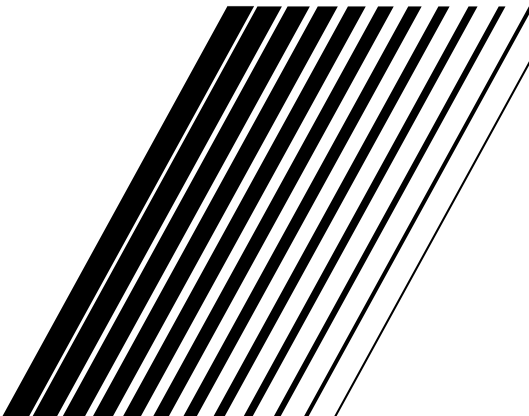

Warnings, Cautions and Others
Avisos, precauciones y otras notas
Advertências, precauções e outras notas
警告，注意及其他須知事項
تحذيرات، تنبيهات وأشياء أخرى

Caution — ⏻/I switch!

Disconnect the mains plug to shut the power off completely. The ⏻/I switch in any position does not disconnect the mains line. The power can be remote controlled.

Precaución — Interruptor ⏻/I!

Desconectar el cable de alimentación para desactivar la alimentación totalmente. Cualquiera que sea la posición de ajuste del interruptor ⏻/I, la alimentación no es cortada completamente. La alimentación puede ser controlada remotamente.

Precaução — Interruptor ⏻/I!

Desconectar o cabo de alimentação para desligar a alimentação por completo. Qualquer que seja a posição de ajuste do interruptor ⏻/I, a alimentação não é completamente cortada. A alimentação pode ser controlada remotamente.

注意— ⏻/I 開關！

無論 ⏻/I 開關在任何位置，電源線的電源還是沒有被切斷，若要將電源完全關閉，應把電源插頭拔離插座。電源開關可用遙控器控制。

تحذير - ⏻/I الطاقة

انزع قابس الطاقة الكهربائية من اجل فصل الطاقة الكهربائية عن الجهاز كلياً. لا يفصل مفتاح الطاقة الكهربائية عندما يكون باي وضع ⏻/I الطاقة الكهربائية عن الجهاز. يمكن التحكم عن بعد بالطاقة الكهربائية.

CAUTION

To reduce the risk of electrical shocks, fire, etc.:

1. Do not remove screws, covers or cabinet.
2. Do not expose this appliance to rain or moisture.

PRECAUCIÓN

Para reducir riesgos de choques eléctricos, incendio, etc.:

1. No extraiga los tornillos, los cubiertas ni la caja.
2. No exponga este aparato a la lluvia o a la humedad.

PRECAUÇÃO

Para reduzir riscos de choques elétricos, incêndio, etc.:

1. Não remova parafusos e tampas ou desmonte a caixa.
2. Não exponha este aparelho à chuva nem à umidade.

警告

爲了減低觸電，火災等危險：

1. 請勿擅自卸下螺絲釘，蓋子或機殼。
2. 切勿讓本機受雨淋或置潮濕環境中。

تحذير

لتجنب خطر الحريق، الصدمات الكهربائية، الخ:
١. لا تقم بفك البراغي، الاغطية أو الخزانة.
٢. لا تقم بتعرض هذا الجهاز للمطر أو للرطوبة.

IMPORTANT FOR LASER PRODUCTS / IMPORTANTE PARA PRODUCTOS LÁSER / IMPOTANTE PARA PRODUTOS LASER / 雷射產品的重要說明 / مهم للمنتجات الليزرية

REPRODUCTION OF LABELS / REPRODUCCIÓN DE ETIQUETAS / REPRODUÇÃO DE ETIQUETAS

انتاج اللاصقات / 標籤內容說明

① CLASSIFICATION LABEL, PLACED ON REAR ENCLOSURE

① ETIQUETA DE CLASIFICACIÓN, PEGADA EN LA PARTE POSTERIOR DE LA CAJA

① ETIQUETA DE CLASSIFICAÇÃO LOCALIZADA NA PARTE POSTERIOR DA CAIXA DO APARELHO.

① 分類標籤，貼在機殼背後。

① لاصق التصنيف، موضوعة على المرفق الخلفي

② WARNING LABEL, PLACED INSIDE THE UNIT

② ETIQUETA DE ADVERTENCIA, PEGADA EN EL INTERIOR DE LA UNIDAD

② ETIQUETA DE ADVERTÊNCIA LOCALIZADA NA PARTE INTERNA DA UNIDADE.

② 警告標籤，貼於機內。

② لاصقة التحذير، موضوع بداخل الجهاز

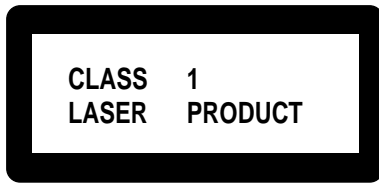

DANGER: Invisible laser radiation when open and interlock failed or defeated. AVOID DIRECT EXPOSURE TO BEAM. (e)

WARNING: Osynlig laserstrålning när denna del är öppnad och spärren är urkopplad. Betrakta ej strålen. (s)

ADVARSEL: Usynlig laserstrålning ved åbning, når sikkerhedsafbrydere er ude af funktion. Undgå udsættelse for stråling (d)

VARO: Avattaessa ja sujalukitus ohitettaessa olet alttiina näkymättömälle lasersäteilylle. Älä katso säteeseen. (f)

1. CLASS 1 LASER PRODUCT
2. **DANGER:** Invisible laser radiation when open and interlock failed or defeated. Avoid direct exposure to beam.
3. **CAUTION:** Do not open the top cover. There are no user serviceable parts inside the Unit; leave all servicing to qualified service personnel.

1. PRODUCTO LÁSER CLASE 1
2. **PELIGRO:** En el interior hay radiación láser invisible. Evite el contacto directo con el haz.
3. **PRECAUCIÓN:** No abra la tapa superior. En el interior de la unidad no existen piezas reparables por el usuario; deje todo servicio técnico en manos de personal calificado.

1. PRODUTO LASER CLASSE 1
2. **PERIGO:** O laser emite uma radiação invisível que é perigosa, caso o aparelho esteja aberto e a trava inoperante ou danificada. Evite exposição direta ao feixe dos raios.
3. **CUIDADO:** Não abra a caixa do aparelho. Não existem peças reparáveis pelo usuário na parte interna da unidade. Solicite assistência técnica somente a pessoal técnico qualificado.

1. 一級雷射產品
2. 危險：當內部鎖定裝置失效或者損壞後，打開蓋板可能會產生不可見的雷射輻射。應避免受到光束直接照射。
3. 注意：請勿打開頂蓋板。本機內部沒有用戶可自行維修的部件；所有維修工作應由有資格的人員完成。

١. صنف ١ منتج ليزري
٢. خطر: أشعة ليزرية غير مرئية عند الفتح والاعطال أو غير الصحيح. تجنب التعرض المباشر للأشعة.
٣. تحذير: لا تفتح الغطاء العلوي. ليس في داخل الجهاز أقسام بمستطاع المستخدم صيانتها؛ إعهد بكافة الأعمال الصيانية لفني مختص.

GENERAL INFORMATION

Care and handling of compact discs

How to handle CDs

When handling a compact disc, do not touch the surface of the disc (reflective silver side — the side without the label).

Since compact discs are made of plastic, they are easily damaged. If a disc gets dirty, dusty, scratched or warped, the sound will not be picked up correctly and, in addition, such a disc may cause the CD player to malfunction.

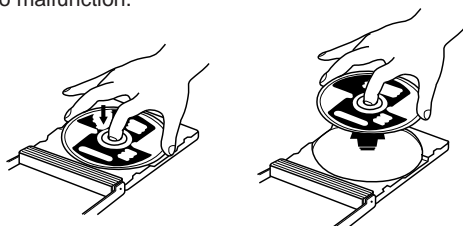

Care of the label side

Do not damage the label side, stick paper or use any adhesive on its surface.

Storage

Make sure that discs are kept in their cases. If discs are piled one on top of another without their protective cases, they can be damaged. Do not put discs in a location where they may be exposed to direct sunlight, or in a place where the humidity or temperature is high. Avoid leaving discs in your car!

Maintenance of discs

If there are fingerprints or dirt adhering to a disc, wipe it with a soft dry cloth, moving from the center outwards.

If a disc is difficult to clean, wipe with a cloth moistened with water. Never use record cleaners, petrol, alcohol or any anti-static agents.

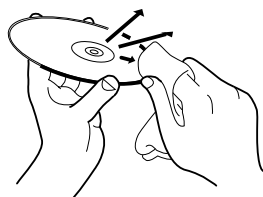

CAUTION

Sometimes during play noise or images may be garbled. This is sometimes due to the disc. (It may not be up to industry standards.) These symptoms are caused by the discs, not by the malfunction of the Player.

Which compact discs can be used?

Many types of compact discs are sold for a variety of uses. The Video CD Player can play the following compact discs:

- **Video CD**
for audio and video (moving picture) reproduction, including multiplex sound.
- **Video CD with Playback Control function**
featuring menu-type operation and super-fine still pictures for audio and video (moving picture) reproduction, including multiplex sound.
- **CD Graphics (CD-G)**
for audio and video (still picture) reproduction, including multiplex sound.
- **Digital Audio CD**
including single discs for audio reproduction.



PlayBack Control



CDs you can't play back

Do not play back CD-ROMs, DVDs, or CD-Is on this equipment. Doing so may generate a noise which can damage your speakers.

Using the remote control

The remote control is ready to use when its batteries are installed properly.

To use it, point its infrared light-emitting window toward the display window of the player and press a button. The operating range of the remote control is up to about seven meters in front of the player and within about 30 degrees to each side — with nothing between the remote control and the player interrupting the beam path.

If pressing a button on the remote control does not produce any response, check to make sure it is pointed correctly and try again. If it still does not function, check the batteries.

BEFORE USING FOR THE FIRST TIME

Basic connections

The Video CD Player must be connected directly to a television set or an amplifier that is connected to a television or monitor. The television set or the amplifier must have audio input jacks for right and left channels and a video input jack.

Select a level, dry location free of dust and vibration, having a temperature maintained between 5 and 35°C (41 and 95°F).

Connecting the player to a TV or amplifier using the Audio Video cord

First connect the Audio Video cord — before connecting the AC power cord.

Firmly insert the yellow pin plug of the Audio Video cord in the yellow VIDEO OUT jack on the rear panel of the player; the red pin plug in the red AUDIO OUT (RIGHT) jack; and the white pin plug in the white AUDIO OUT (LEFT) jack. (The RIGHT and LEFT output jacks are for the right and left audio channels.)

Then make sure that the television, amplifier or receiver is turned off, disconnect the AC power cord, and firmly insert the pin plugs at the other end of the Audio Video cord into the matching video and audio INPUT jacks.

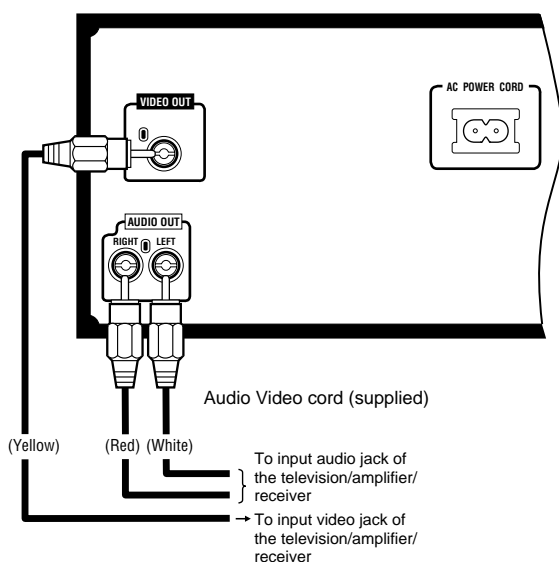

Video out select

Set the VIDEO OUT SELECT switch on the rear panel to NTSC, PAL, or PAL AUTO mode according to your television system.

NTSC for NTSC exclusive TV

PAL for PAL exclusive TV

PAL AUTO for Multisystem TV

PAL AUTO detects the formula of the disc (NTSC/PAL) automatically and plays the image on the screen correctly.

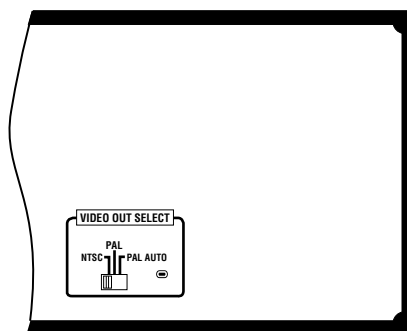

Notes

- When you play an NTSC disc in PAL AUTO mode on a PAL exclusive TV, the image may be distorted. If the signal doesn't synchronize, change the mode to "PAL".
- Select the mode before you play the disc. If you change the mode during play, images may get distorted. In this situation stop the player and reset the mode.
- When you play an NTSC disc in PAL AUTO mode on a Multi system TV, the image may blink for a moment. This symptom is caused by the Player detecting the formula of the disc, not by a malfunction of the Player.

Connecting the power cord

IMPORTANT (not applicable for China)

Check the setting of the *LINE VOLTS switch on the rear panel of the player.

Change the setting if the switch is not set for the main voltage supplied to your home.

After the audio-video connectors had been connected, insert the female end of the power cord firmly into the AC POWER CORD socket located on the rear panel of the player. Then insert the male end of the power cord into the wall outlet.

When the power cord is connected, the STANDBY indicator on the left-hand side of the player's front panel comes on. [See "overview of Controls" for a description of the controls on the player.]

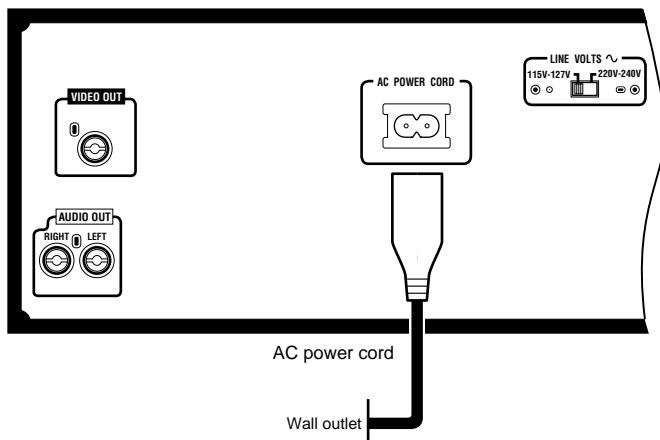

Installing batteries

Putting batteries in the remote control unit

The battery compartment is located on the back of the remote control unit.

1. Press down on the triangular mark of the compartment cover, and slide the cover off to open the compartment.

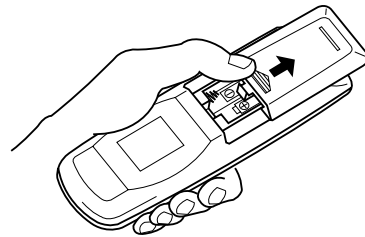

2. Place the two accessory R6P(SUM-3)/AA(15F) batteries in the remote control unit according to the polarity markings ("+" and "-") inside the compartment and on the batteries.

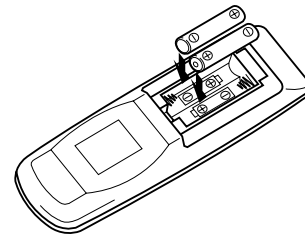

3. Place the cover over the compartment, press down lightly, and push it upward until it snaps on.

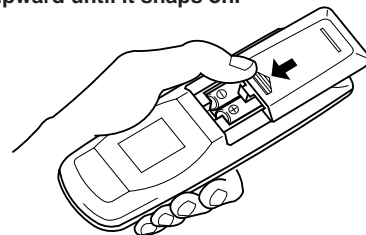

The batteries last about one year with normal use. If function of the remote control become erratic, replace the batteries.

Precautions for the safe use of batteries

Observe the following precautions for the safe use of batteries. Their life will be shortened, they may burst or their contents may leak if they are used improperly.

- Remove batteries from the remote control if it is not going to be used for a long period of time.
- Remove dead batteries and dispose of them properly.
- Never leave dead batteries lying around, take them apart, mix them with other refuse, or throw them into an incinerator.
- Never touch liquid that has leaked out of a battery.
- Do not mix new and old batteries, or batteries of different types, when replacing them.

OVERVIEW OF CONTROLS

The following is an explanation of the basic function of controls on the front panel of the Player and the remote control. The function of some controls may be restricted in actual use depending on the on-going operations. The remote control has fifteen (15) unique function buttons in addition to those on the player.

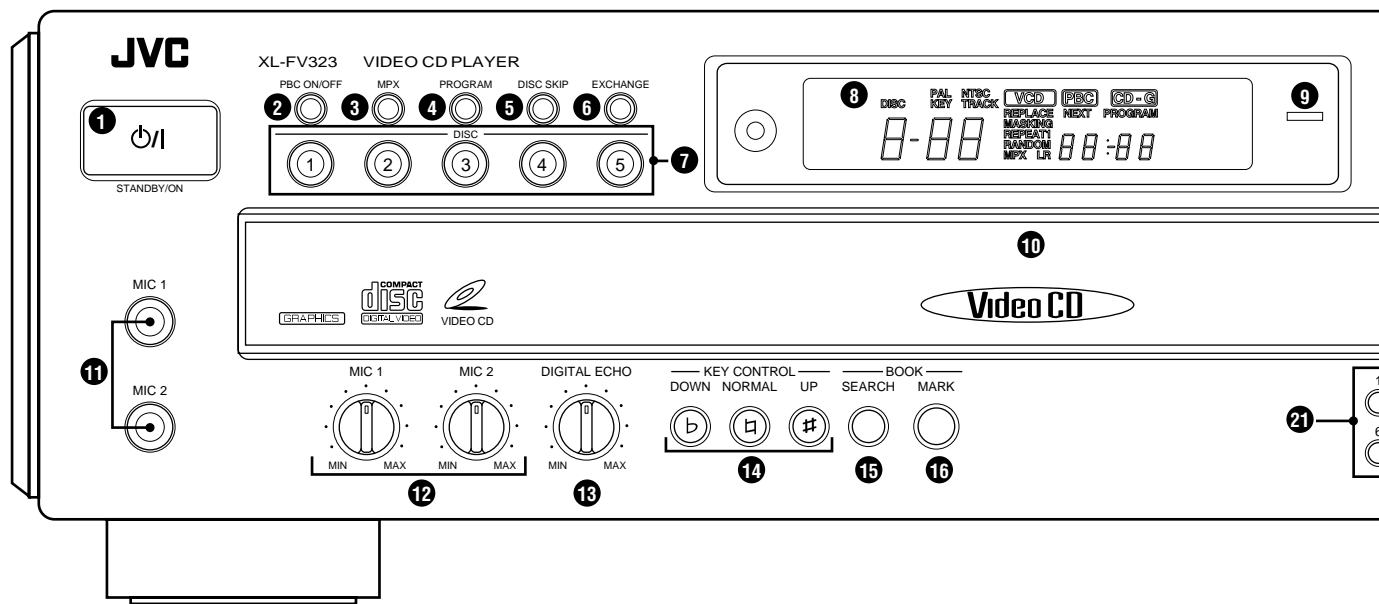

Front panel

(Controls marked (R) have equivalents on the remote control.)

- ➊ **⏻ button (R)**
Turns the power on and off.
- ➋ **PBC ON/OFF button**
Selects On or Off of the Playback Control function of the video CD.
- ➌ **MPX button (R)**
Activates the multiplex function, which switches to NORMAL (stereo), L-ch monaural and R-ch monaural.
- ➍ **PROGRAM button (R)**
Any desired sequence of tracks can be programmed with the number keys and the +10 button.
The program button cannot be used while the Playback Control function is activated.
- ➎ **DISC SKIP button**
Switches the selected disc from 1 to 5, then back to 1.
- ➏ **EXCHANGE button**
Opens the disc tray to change the discs which are not being played back.
- ➐ **DISC buttons (R)**
To select a disc, press the desired disc number (1-5). The unit searches for the selected disc and playback starts automatically.
- ➑ **Display window**
Shows information about the status of operation.
- ➒ **STANDBY indicator (Red)**
Lights when the power cord is connected and the power is turned off. The STANDBY indicator is not lit when the player is turned on.
- ➓ **DISC1 to DISC5 trays (R)**
Used to load discs. To insert/remove one or up to 5 discs.
- ➔ **MIC jacks (1, 2)**
Used for connecting microphones (1, 2). The jacks correspond to MIC 1 to 2 volume knobs.
- ➕ **MIC1, MIC2 knobs**
Adjusts volume of the microphone corresponding to MIC number.
- ➖ **DIGITAL ECHO knob**
Adjusts the degree of the echo effect for the microphone (1, 2) voice.
- ➗ **KEY CONTROL buttons (R)**
Transposes the music key.
DOWN ♭ button: used to flatten by a half tone.
NORMAL ♮ button: returns to original key tone.
UP # button: used to sharpen by a half tone.
- ➘ **BOOK SEARCH button (R)**
Retrieves video segments which you marked with a bookmark. (See page 14.)
- ➙ **BOOK MARK button (R)**
Places a "bookmark" at video segments you want to find later for almost instant replay. (See page 14.)
- ➚ **⏮ / ⏭ PREVIOUS / NEXT buttons (R)**
During operation with the Playback Control function
Invokes previous or next screen.
During operation without the Playback Control function
Skips forward or backward quickly from current track being played.
- ➛ **■ (STOP) button (R)**
Stops play.
- ➜ **⏸ (PAUSE) button (R)**
Temporarily suspends playing. Video motion freezes and audio reproduction stops. Pressing the button repeatedly advances the picture frame-by-frame. (Video CD only)
- ➝ **▶ SELECT (PLAY) button (R)**
Starts to play the disc.
- ➞ **Number keys (1 to 10, +10) (R)**
Used to specify a track number for playing, changing, or programming. To operate numbers above ten (10), press the +10 button once. The number keys (1 to 10) are then assigned the numbers 11 to 20 instead of 1 to 10. The maximum key number assignment is 99. In PBC function operation, the number keys are additionally utilized for the selection of menu items. See page 17 "Operation of Playback Control function".
- ➟ **↶ RETURN button (R)**
Utilized for operation with the PBC function. This button is used to return to a menu screen during play.
- ➠ **▲ OPEN/CLOSE buttons**
Used the ▲ (OPEN/CLOSE) button to open and close the disc tray.

The controls with identical names on the Player and on the remote control have the same function and are used in the same manner.

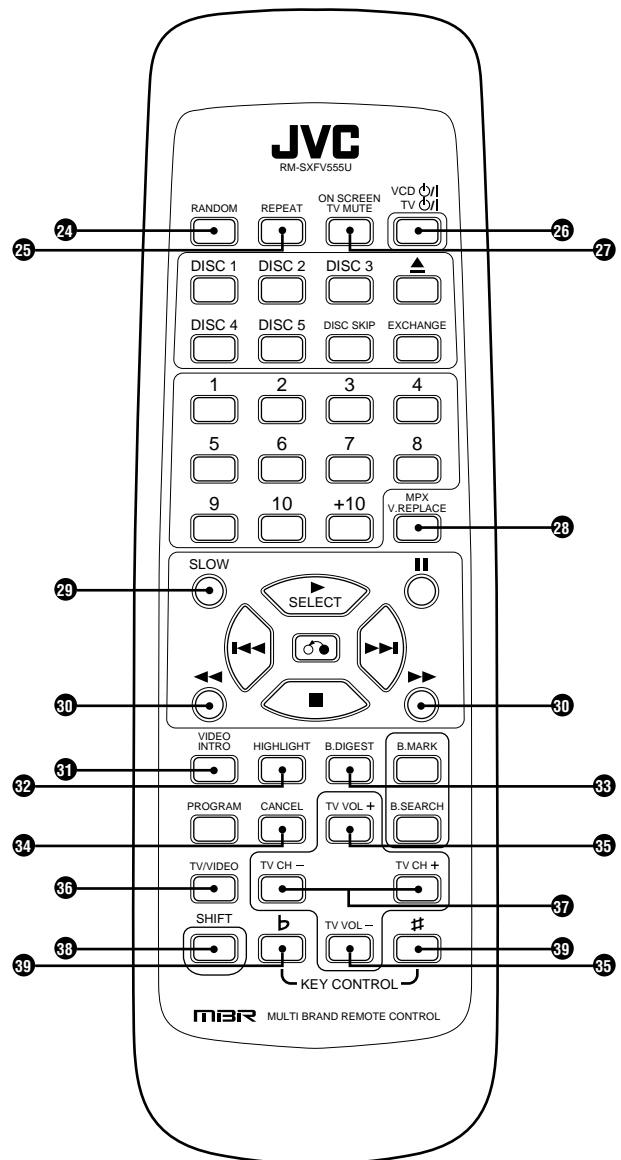
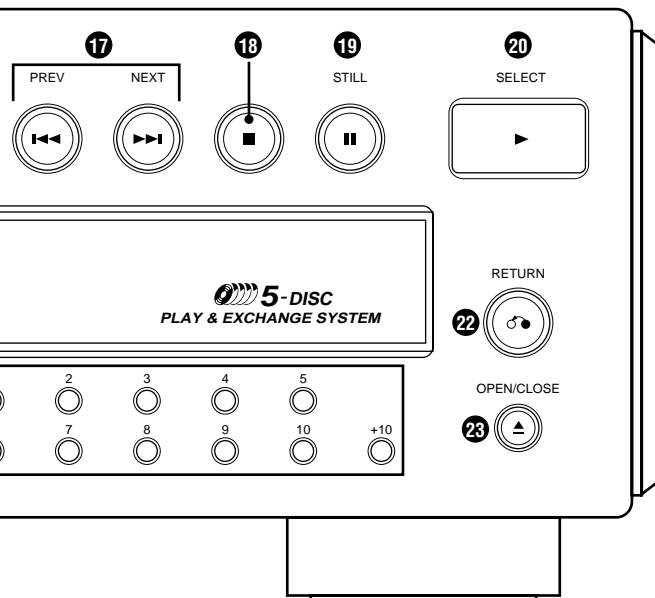

Remote control unit

- 24 RANDOM button**
Changes the disc track program to a random sequence from disc 1 through 5 respectively.
- 25 REPEAT button**
Repeats a track or inserted discs from 1 to 5.
- 26 VCD ϕ /I/TV ϕ /I button**
Turns the player on and off.
When pressed after you hold down the SHIFT button, turns the TV on or off.
- 27 ON SCREEN/TV MUTE button**
Controls whether or not control and operation status are displayed on the television screen or monitor.
When pressed after you hold down the SHIFT button, mutes or demutes the TV sound.
- 28 MPX/V.REPLACE button**
Activates the multiplex function. (See page 12)
When pressed after you hold down the SHIFT button, activates the vocal replace function, inserting your voice in place of the disc vocals.
- 29 SLOW button**
Starts slow-motion playback.
- 30 \lll / \ggg button**
Shifts the playing location backward and forward quickly. Holding down the button causes it to go much faster.

- 31 VIDEO INTRO button**
Applies to video CDs only. The introductory five (5) seconds of tracks on a video CD are displayed on the television screen in order to present the contents of the video CD.
- 32 HIGHLIGHT button**
Applies to a video CD to see highlights of a track. Displays the first (5) seconds of each of nine (9) equal-time segments of the track.
- 33 B. DIGEST button**
Displays video segments you marked with the Bookmark function. (See page 14.)
- 34 CANCEL button**
Cancels the latest track you have programmed. The latest programmed track is canceled whenever you press this button. Also used to cancel a bookmark.
- 35 TV VOL + / TV VOL - keys**
Turns the TV volume up or down.
- 36 TV/VIDEO button**
Used to preset the remote control unit, to control some functions on your TV set. (See page 9.)
- 37 TV PROG - / TV PROG +**
Changes the television channel.
- 38 SHIFT button**
Used together with other keys for various functions. (See page 9)
- 39 KEY CONTROL**
Changes the key in which the music plays. (See page 16.)

BASIC OPERATIONS

Now you can play a variety of video CDs!!

Display window

The display window indicates many aspects of control and operation status.

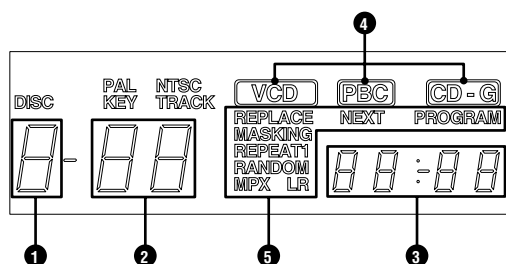

- ❶ Shows the disc number being played.
- ❷ Shows mainly the total number of tracks and the track number being played.
- ❸ Shows mainly the cumulative time (minutes and seconds) of the track. Afterward, total time of the disc is displayed.
- ❹ The combination of VCD, PBC, and CD-G indicators shows the type of disc being played.
- ❺ Each indicator in this area lights when the corresponding function is activated.

Preparation for playing

Turn on the television set, amplifier or receiver to which the Player is connected. Then select the proper channel and mode to operate the Player.

CAUTION

Set the sound volume of the television set, amplifier or receiver to which the Player is connected to a reasonable level before starting playback.

Press the button on the front panel or the VCD (TV) button on remote control. The STANDBY indicator goes out.

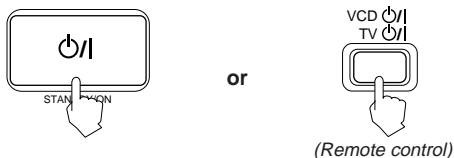

The display window shows the initial information as shown below.

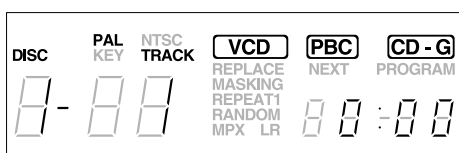

Loading discs in the disc tray

Use the (or on the remote control) button to open and close the disc tray.

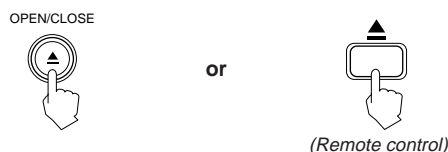

1. Open the disc tray by pressing the (OPEN/CLOSE) button.
2. Place discs on the disc tray according to the groove with their label side up.
 - To turn the disc tray press DISC SKIP button.
3. Close the disc tray by pressing the (OPEN/CLOSE) button.

CAUTION

When loading discs in the disc tray, be sure to put the discs according to the groove. Otherwise, the discs will be damaged when the disc tray is closed, and cannot be removed from the unit.

Starting to play disc(s)

Press the SELECT (PLAY) button. The Player starts to play from the disc indicated in the display window.

For individual track selection, use the number keys or the PREV/NEXT buttons.

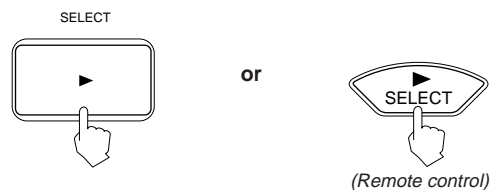

When you start play, the Display window shows the disc number and the track number being played.

If the PBC function is activated, the display window shows "Pb".

When you press SELECT button during play, the disc will restart from the beginning of the track except when the PBC function is activated.

Specifying a desired disc

While the player is in play or stop mode:

Use the DISC buttons (1-5).

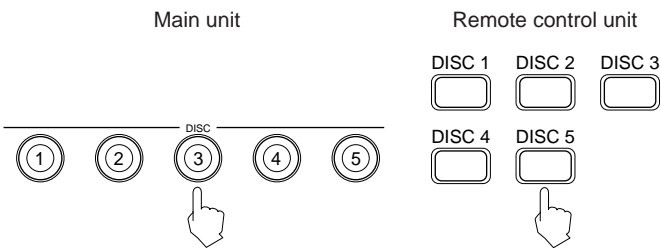

To select a disc, press the desired disc number (1-5). The unit searches for the selected disc and playback starts automatically.

Using track number keys

Press the number keys to select track numbers.

On the Player 1 to 10 and +10 key

Example: For track number 5, press 5. For track number 15, press +10, then 5. For track number 20, press +10 button, then 10. For track number 32, press +10 three times, then 2.

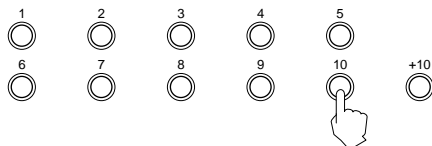

On the remote control 1 to 10 and +10 key

Select track numbers as described above.

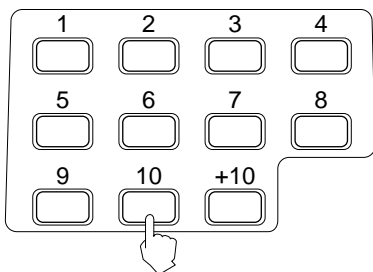

Note

- When you press the number keys, the track will start playing without pressing ► SELECT button.

Stopping play

Press the ■ (STOP) button to stop play at any time.

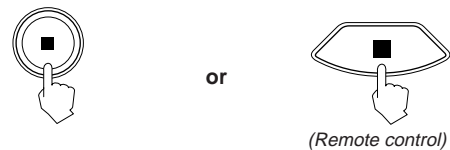

Pausing play

Press the ■■ STILL (PAUSE) button to temporarily suspend play.

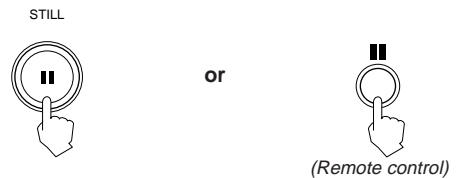

When the ■■ STILL (PAUSE) button is pressed once, "PAUSE" appears on the television screen, the video motion freezes and the sound is turned off. The still picture advances frame-by-frame each time the ■■ STILL (PAUSE) button is pressed. This frame-by-frame function is effective only for video CDs.

To release the pause, press the ► SELECT button. During "PAUSE" the time counter on the display will blink.

Skipping to a desired disc

Use the DISC SKIP button.

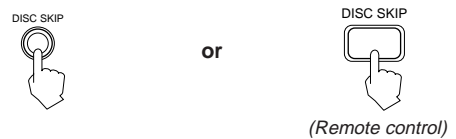

Each time the DISC SKIP button is pressed, the selected disc number changes.

Auto search/Manual search

During play, pressing the **◀◀** button once causes the Player to replay the current track from the beginning. Pressing the **▶▶** button once causes the Player to skip to the next track. The current position on the disc is displayed on the television screen.

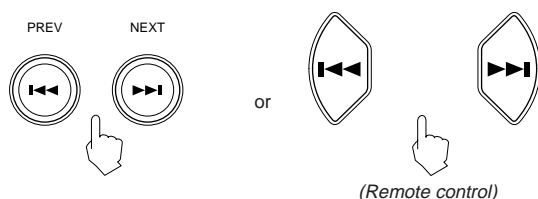

Holding down the **◀◀** / **▶▶** buttons on the player or the **◀◀** / **▶▶** buttons on the remote control unit causes the disc to fast forward or reverse.

Continuing to hold down the buttons causes it to search much faster.

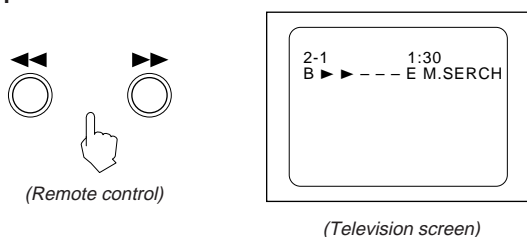

Note

- In some circumstances, these functions are not available when the PBC function is activated.

Slow-motion playback

Press the **SLOW** button to play in slow-motion. By pressing the **SLOW** button consecutively, the playback speeds are cycled as shown below.

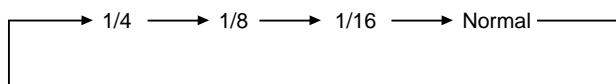

Note

- This function only can be used when a moving picture is show on the screen.

Changing discs during playback

During playback of a disc, you can change other discs in the disc tray without stopping playback.

Press the **EXCHANGE** button. The disc tray opens and you can change the discs inside.

Note that you can change only three discs in the opening area.

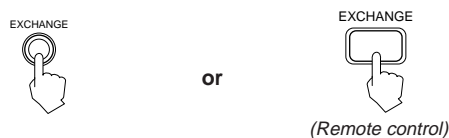

After changing the discs, press the **EXCHANGE** button again to close the disc tray.

It is also possible to change the discs during program playback or random playback, following the above procedure.

Note

- When the disc tray is opened by pressing the **EXCHANGE** button, it is not possible to close it by pushing it back with hand. Press the **EXCHANGE** button again or the **▲ OPEN/CLOSE** button to close the tray.

Using the remote control

Presetting the remote control to operate your own TV

You can use the Player's remote control unit to control some functions on your TV set (e.g., turning the TV on and off, adjusting volume, or selecting channels). First, though, you must preset the remote control to make it compatible with your TV.

Operation

1. Check the Preset Code Table (page 10) to determine the two-digit brand code number for your TV.
2. While holding down the TV/VIDEO button on the remote control, press the Number keys to insert the two-digit brand code number. (For example, if the code number is "28", press Number key 2, then 8. If the first digit is a "0", press 10. Thus, if the code number is "09", press Number key 10, then 9. If the code number is "10", press Number key 1, then 10. If it is "20", press Number key 2, then 10.)

Notes

- Before the remote control unit leaves the factory, the brand code number is set as No. 01 (JVC).
- Depending on your television set's age and other factors, brand code numbers may be different from those shown in the table. In such a case, try out other codes until you find one that corresponds to your television.

3. While still holding down the TV/VIDEO button, press the ■ (STOP) button on the remote control.



4. The TV is turned off if the code number is correct. Repeat the procedure from the beginning if you weren't successful the first time.

Using the SHIFT button on the remote control unit

You can control other functions with the remote control, simply by pressing a button while holding down the SHIFT button. Some of these functions are useful for Karaoke and Video CD playing, others for controlling the TV.



■ SHIFT button functions for Karaoke and Video CD playing

SHIFT + MPX ⇒ VOCAL REPLACE

■ SHIFT button functions to control the TV

SHIFT + VCD POWER ⇒ Turns the TV on and off

SHIFT + ON SCREEN ⇒ TV MUTE (Mute the TV sound)

SHIFT + 1 ⇒ TV Channel 1

SHIFT + 2 ⇒ TV Channel 2

⋮

SHIFT + 10 ⇒ TV Channel 0*

SHIFT + SLOW ⇒ 1 - (The first digit of a TV Channel number 10 to 19. Push a Number key to insert the second digit.)*

SHIFT + PAUSE ⇒ 2 - (The first digit of a TV Channel number 20 to 29. Push a Number key to insert the second digit.)*

SHIFT + +10 ⇒ -/- - (To change a one - digit or to change a two - digit TV channel number, using a Number key.)*

SHIFT + ► ⇒ ENTER (Push after choosing a channel. This function registers the channel you have chosen.)*

Note

- The asterisk * indicates that these operations do not work for some manufacturers' television sets.

BASIC OPERATIONS

Preset code table

No.	Television manufacturer
01	JVC
02	PANASONIC
03	SONY
04	SHARP
05	TOSHIBA/BEIJING/CHANGHONG
06	MITSUBISHI/CHANGHONG
07	HITACHI
08	SANYO
09	FUNAI
10	AIWA
11	DAEWOO
12	SAMSUNG
13	LG (GOLDSTAR)
14	THOMSON
15	FERGUSON
16	PHILIPS/TCL/CHANGHONG
17	GRUNDIG
18	ITT
19	MIVER
20	FINLUX
21	NOKIA
22	NEC
23	JINXING/PEONY1
24	PEONY2
25	PEONY3/CHANGHONG
26	KONKA
27	PEIJIN/NOBLEX
28	TCL

VARIOUS UNIQUE FUNCTIONS

Various functions can enhance your enjoyment

Display of operations status

Preparation

This function is controlled by the remote control.

Operation

Press the **ON SCREEN** button on the remote control. By pressing the **ON SCREEN** button, the following information may be easily and quickly displayed or removed from the television screen.

Time, Echo effect, Key control, Program, Repeat, Random, Multiplexing, Vocal replace, Vocal masking, Bookmark, etc.

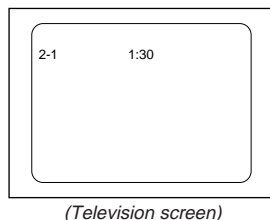
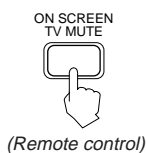

Programming the track sequence you want

Preparation

It is not possible to enter programming mode during play. If playing, stop the player with the **■ (STOP)** button.

Operation

1. Press the **PROGRAM** button to enter the programming mode. **PROGRAM** is displayed in the Display Window.



or

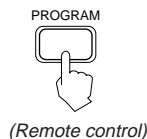

2. Specify the disc by a **DISC** buttons (1-5) button and then the track by the number keys successively. You can program up to nine (9) tracks by repeating this procedure.
3. To play the programmed tracks press the **▶ SELECT** button.

Notes

- The track number playing, next track programmed, and number of programmed tracks are displayed from the left-top of the television screen. You may use the **ON SCREEN** button to delete this information.
- Once the programmed track is played, it is deleted from the program.
- You may also program tracks additionally during the program playback as long as the number of the programmed tracks does not exceed 9.

Canceling a programmed track

Operation

There are three (3) canceling functions (canceling the last programmed track, canceling the current track, canceling the next track to be played).

- To cancel the last programmed track press the **CANCEL** button on the remote control and the last programmed track will be canceled. This can be done while a disc is playing.

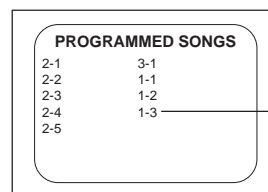

(Television screen)

The number located lowest is the last track programmed.

- To cancel the current track press **■ (STOP)** button.
- To cancel the next track, wait until the current track has finished and press the **▶▶** button and the next track will be canceled and the unit will go to the next programmed track.

Note

- To verify the tracks you programmed, stop the Player and see **ON SCREEN** information

Clearing a program

To delete all programmed tracks you have entered, press the **■ (STOP)** button and then the **PROGRAM** button while the player is in stop mode. "PROG OFF" will be displayed on the television screen.

To stop the program playback in the middle, press the **■ (STOP)** button. Pressing the **▶ SELECT (PLAY)** button again causes the Player to start playing from the next programmed track.



VARIOUS UNIQUE FUNCTIONS

Repeating tracks

It is possible to repeat all discs or only a single track.

Preparation

This function is controlled by the remote control.

Operation

By pressing the REPEAT button consecutively, REPEAT modes are cycled as shown below.

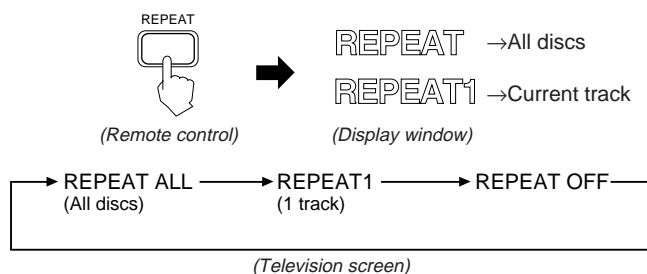

Notes

- When playing a programmed sequence of tracks, only one track repeat is available.
- The Repeat function is not available when the player is set to PBC ON.
- Only REPEAT ALL is available when the player is in RANDOM mode.
- You cannot repeat the segment between bookmarks.

Randomly playing tracks

Preparations

- This function is controlled by the remote control.
- This function plays tracks randomly from one disc.
- This function is available while the player is in stop mode.

Operation

Press the RANDOM button and random playing will start.

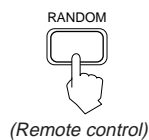

To stop the random playback, press the ■ (STOP) button.



To cancel the random playback, press the RANDOM button again after stopping the Player.

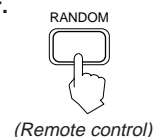

Note

- Random is not effective in program mode.

Playing a multiplex sound CD

This function is used for multiplex sound discs.

See manuals attached to discs for detail information.

Operation

By pressing the MPX button consecutively, channel multiplexing modes are cycled as shown below.

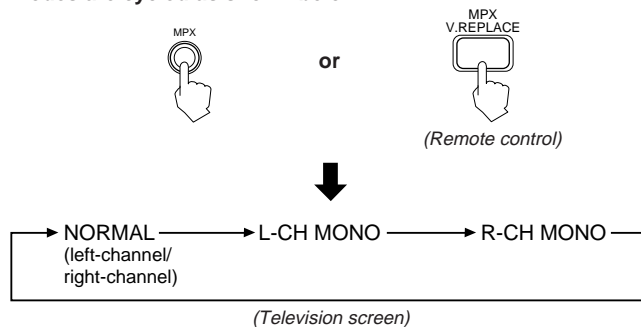

Viewing the VIDEO INTRO of a video CD

Preparation

When you play a video CD with the Playback Control function, the mode switch should be in the PBC OFF mode.

Operation

1. Play the disc you want to see a digest of.
2. Press the VIDEO INTRO button on the remote control just after starting disc play. Then the Player starts to display in sequence the first five (5) seconds and track numbers of all tracks on the disc.



3. To select a track during the video intro mode, press the number key corresponding to the item number on the television screen.

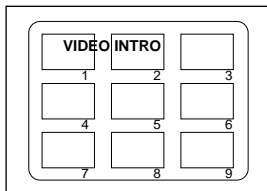

(Television screen)

Notes

- The Video intro function is not available in the Random mode.

Programming during VIDEO INTRO

Operation

1. Stop play.
2. Press the PROGRAM button so that PROGRAM is lit in the display.
3. Press the disc button you want to play, and enter 1 on the number keys.
4. Press the ► SELECT button and then, after the disc has started to play, press the VIDEO INTRO button.
5. The Player starts to display in sequence the first five (5) seconds and track numbers of all tracks on the disc. Select the numbers you want to program. You can program nine (9) tracks.
6. Press the ► SELECT button to play.

Viewing the highlights of a video CD

This function is used for a movie video CD.

Preparations

- When you play a video CD with the Playback Control function, the mode switch should be in the PBC OFF mode.
- This function is controlled by the remote control unit.

Operation

1. Start playing the track you want to see the highlights of.
2. After the track begins to play, press the HIGHLIGHT button on the remote control.



(Remote control)

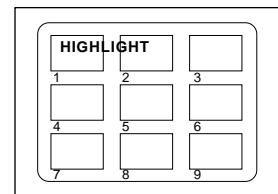

(Television screen)

3. To select one of the nine (9) segments, press the number key (1 to 9) of the segment which you want to play.

Notes

- When you choose a highlight it will start from five (5) seconds before the shown time below each segment.
- The segments are each of nine (9) equal-time divisions of the track.
- Nine (9) different highlights are displayed for one (1) minute.
- If no number key is pressed for a minute after the Highlight view appears on the screen, the screen is replaced with the Highlight view of the next track.
- While in VIDEO INTRO or HIGHLIGHT, sometimes image is partially distorted. This symptom is caused by noise in the disc itself or incorrect manufacturing, not by a malfunction of the Player.

Playback with the Bookmark function

Marking segments for later viewing with the Bookmark function

The Bookmark function lets you mark segments of a Video CD, so that you can have almost instant playback of desired scenes later. You can mark segments on up to ten discs, with a maximum of nine segments per disc.

Even if you take the disc out of the player, its bookmarks will stay stored for later use, until you erase them.

Operation

While playing the disc, press the **BOOKMARK** button at the segments you want to mark for later playing. Bookmark numbers appear on the television screen.

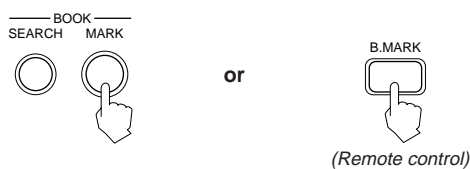

Notes

- The Bookmark function works only with Video CDs.
- The **BOOKMARK** function is most easily used when the Player is in PBC OFF mode.
- When you begin marking segments in any one of the PBC ON or OFF, all subsequent markings and searches for that disc must be done in the same PBC mode.
- If you mark a segment when the Player is set for the Playback Control (PBC) function, the mark is placed at the beginning of the scene.

Using the BOOKMARK DIGEST button

1. Press the **BOOKMARK DIGEST** button on the remote control while playing the disc.



2. The marked segments will be highlighted on the screen, with their respective numbers (maximum of nine).
3. Press the Number key (1 to 9) which corresponds to the number of the segment where you want to start play.

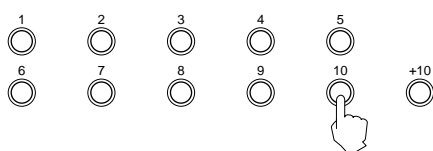

Note

- If you plan to use the **BOOKMARK DIGEST** function, register all bookmarks with the player in the same PBC mode.
- The **Bookmark Digest** function is not available in PBC function.

Using the BOOKMARK SEARCH button

■ With PBC off

1. Press the **BOOKMARK SEARCH** button while playing a disc. The **BOOKMARK SEARCH** light will flash on and off, indicating the Player is in the **Bookmark Search** mode.

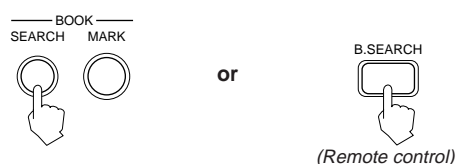

2. Press the Number key (1 to 9) which corresponds to the number of the segment where you want to start play. Or press the **◀◀** or **▶▶** button until the desired bookmark number appears on the screen.

Note

- To exit the **Bookmark Search** mode and return to regular viewing, press the **BOOKMARK SEARCH** button again.

■ With PBC on

1. Press the **BOOKMARK SEARCH** button while playing a disc. The play will stop and the Player will enter **Bookmark Search** mode.



2. Press the Number key (1 to 9) which corresponds to the number of the segment where you want to start play.

Note

- The **Bookmark Search** function ends automatically, and the player returns to regular viewing.

Canceling individual bookmarks

1. If the Player is in PBC OFF mode, start playing the segment whose bookmark you want to cancel.
2. Press the **CANCEL** button on the remote control. The bookmark for the segment immediately preceding the part you are playing will be canceled. (If the Player is in PBC ON mode, the bookmark with the highest number will be canceled.)



Note

- When you cancel a bookmark number, all subsequent bookmark numbers change, moving up one level to fill the gap you made.

Canceling all bookmarks on individual discs

- **When the disc whose bookmarks you want to cancel is in the Player:**

This cancels all bookmarks on the disc whose play you stopped. This function is available while the player is in stop mode.

Keep holding down the **|| STILL (PAUSE)** button on the player until bookmark information on the television screen stops blinking.

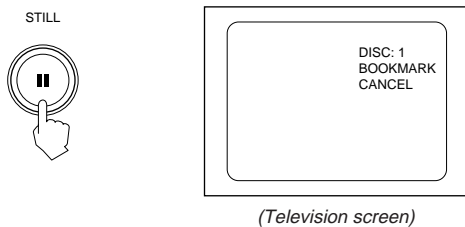

- **When the disc is not in the Player:**

This cancels all bookmarks on the disc which was played the least recently.

Keep holding down the **■ (STOP)** button on the player until bookmark information on the television screen stops blinking.

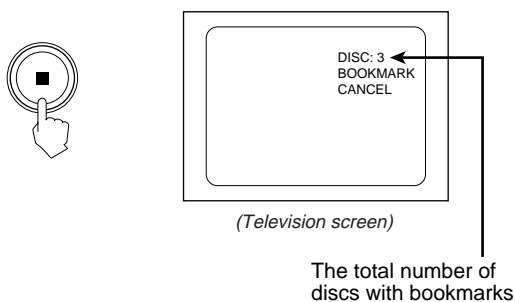

The total number of discs with bookmarks

Using a microphone

Using a wired microphone

Operation

Up to two (2) microphones can be connected to the MIC 1/2 jacks on the front panel.

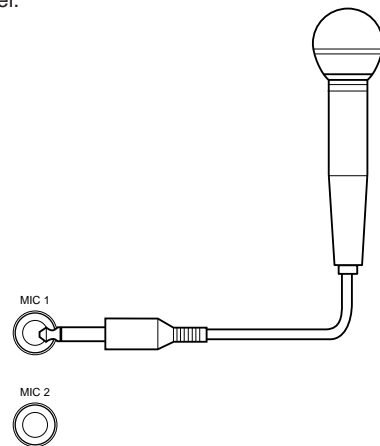

1. Turn on the microphone switch.
2. Turn the MIC 1, MIC 2 knobs clockwise (level up) or counter-clockwise (level down) as desired.

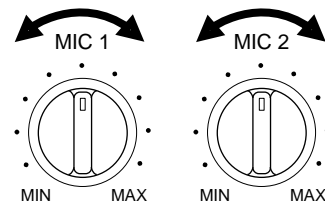

ATTENTION

When you are not using the microphone, set the MIC switch to OFF.

Be sure to remove the microphone

Note when connecting the sound output to the input of a TV or VCR: If an excessively strong signal is given to a unit through a microphone, for example when using Karaoke, it may cause an adverse effect such as distorted sound. Lower the sound volume using the microphone control.

Karaoke etiquette

Think of your neighbors when you are enjoying karaoke music. Particularly late at night, the sound you enjoy may reach your neighbors more than you expect. Common sense and courtesy are always appreciated.

Adjusting music key

Press the **KEY CONTROL** buttons (\flat or \sharp) to change the key in which the music plays. To return the music to its original key, press the **NORMAL** button.

You can adjust the music using the remote control unit also.

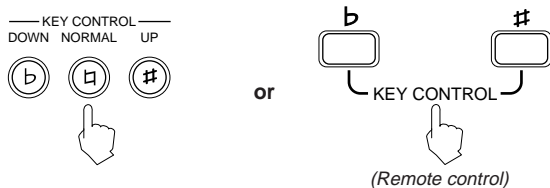

Notes

- The degree the key has been sharpened or flattened is displayed on the television screen.
- When the song ends the key control will return to NORMAL mode automatically.

Adjusting echo effect

Turn the **DIGITAL ECHO** knob clockwise (level up) or counter-clockwise (level down) to adjust the echo effect as desired.

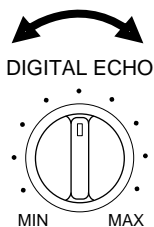

Vocal replace

Preparation

This function is used for multiplex sound discs.

Operation

1. While holding down the **SHIFT** button, press the **MPX/V.REPLACE** button during play or stop. **REPLACE** will appear on the display window and **V.REPLACE** will appear on the television screen. When you start singing, the disc vocal is removed and your voice is inserted into the music.



2. To cancel voice replacement, hold down the **SHIFT** button and press the **MPX/V.REPLACE** button again.

Note

- You cannot use the Vocal Replace function with a disc that has vocals recorded on the left channel.

OPERATION OF PLAYBACK CONTROL FUNCTION

Playing Video CDs with Playback Control function

This Player provides a Playback Control function which utilizes a procedure (menu selection) programmed in a video CD. The playback operation procedure may differ depending on the disc you use.

The Playback Control function is described below and in the figure.

- High-resolution still image display - Super-fine reproduction of still images with more than 4 times the resolution of video tape.
- Menu-driven playback - interactive menus for easy selection of tracks

Preparation

- A video CD with the Playback Control function is required for this operation.
- The PBC button must be set to ON.
- The buttons available for use are the number keys, the **◀◀ / ▶▶** PREV/NEXT buttons, **▶** SELECT button, and **↻** RETURN button.

Button functions

- Number keys Select a specific menu item from the television screen or monitor.
(Including +10 button)
- ◀◀ / ▶▶** PREV/NEXT buttons .. Move through menu etc.
- ▶** SELECT button When "▶" or "SELECT" is displayed on the television screen, pressing this button jumps to the specific picture.
- ↻** RETURN button Returns to the menu.
- (STOP) button Stop operations.

Operation

1. Verify that the PBC button is set to ON.
2. Press the DISC (1 through 5) or **▶** SELECT button, and then the Player starts up the PBC function. "Pb" is shown in the Display window. The main menu are displayed on the television screen.

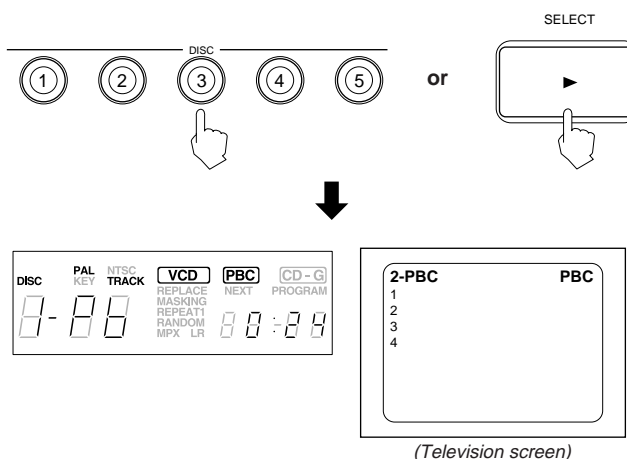

3. To move through the disc menus, press the **◀◀ / ▶▶** PREV/ NEXT button.

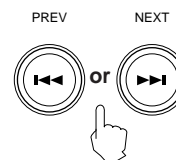

4. When the disc menu you want appears, select an item in the menu by using the number keys. The numbers on the number keys correspond to the menu item numbers.
5. To return to a menu press the **↻** RETURN button.



Notes

- Page numbers in the disc menu show that preceding pages exist. To move from the current menu, press the **◀◀ / ▶▶** PREV/NEXT button.
- If you have no desire to use the PBC function when playing a disc with the PBC function, select "PBC OFF" mode using the PBC ON/OFF button before playing.
- If you change the PBC mode from ON to OFF when playing back a PBC disc, playback will stop. Operate the procedure above again from the beginning.
- If you press the number keys directly to select the track before playing, you can't enter PBC mode.

Video CDs with Playback Control function

What is Playback Control function?

The Playback Control function, allows you to enjoy menu-driven operation and high-resolution still images having a resolution four times greater than moving pictures.

- **Menu-driven playback**
You can interact with the screen using a menu display to select and play an entry.
- **High-resolution still image display**
You can display high-quality images four times clearer than moving pictures.

Example of playback using the Playback Control function

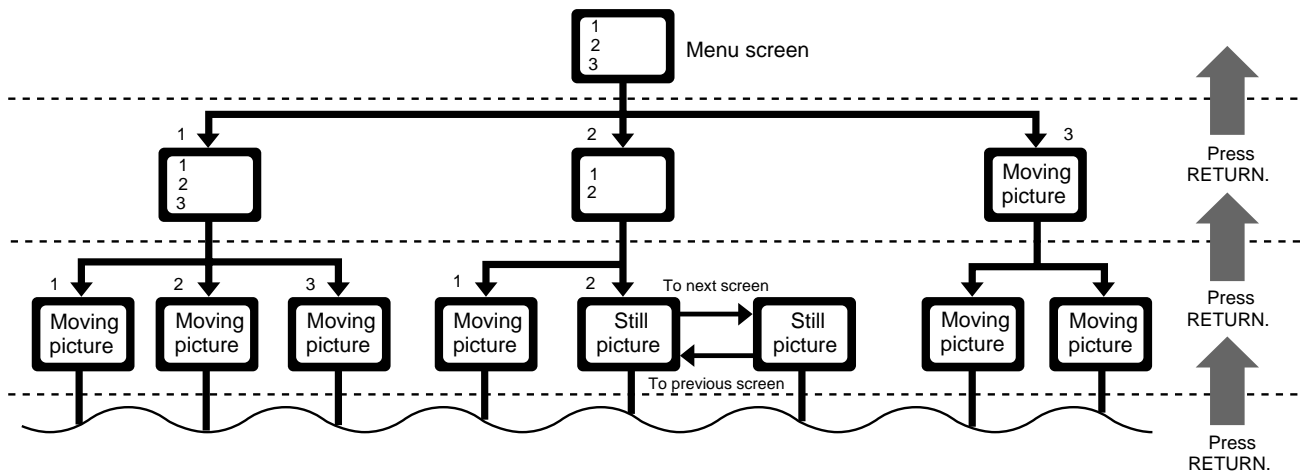

A selection menu is displayed when you start playing a video CD disc with the Playback Control feature. The selection menu shows a list of numbers for selection. Some discs may show moving pictures or a divided screen.

1. When a list of numbers is displayed, selecting a number shows its contents.
2. When "▶" or "SELECT" is displayed on the television screen, pressing this button jumps to the specific picture.

3. When the selection menu is redisplayed after you have played your selection, selecting a number again replays its contents. (Some discs may show the menu screen several times.) When "Next" and "Prev" are shown, pressing "NEXT" or "PREV" can change the selection menu.
4. After playback, press ⏪ RETURN to go back to the previous screen. To stop playback, press ■ (STOP).

Note

- When a menu is displayed for a long time (about 10 minutes), the screen background automatically fades out to prevent screen burn-in while the setting is suspended.

RESTRICTING USE OF YOUR DISCS

Locking a disc with the Read-Protect function

Locking a disc

The Read-Protect function restricts viewing of a disc. Only people who know the code can unlock the disc. You can lock only Video CDs (up to 10 discs).

Notes

- You cannot lock a disc while it is playing, or when the VCD light is blinking (i.e., immediately after turning on the player or shutting a disc tray). Stop the disc, then lock it.
- All Read-Protect functions are performed using buttons on the Player, not on the remote control.

Operation

- Play the disc for a moment, then press the  (STOP) button.



- Hold down the NEXT button on the Player for at least three seconds. The track and time numbers are no longer displayed.



- Press the Number key "8" four times. The Display window indicates "Loc."

Now the disc cannot be viewed. You can open and close the tray and you can turn the Player power on and off, but no other functions are available for this locked disc.

Notes

- PROTECT is displayed on the television screen.

Cut out the following instructions and keep them separately, to ensure privacy.

Canceling Read-Protect

Operation

- Place the disc in a tray, then press the DISC button (1 - 5) for that tray. PROTECT is displayed on the television screen.

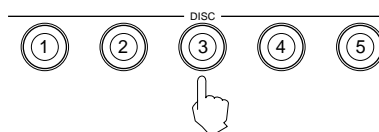

- Hold down the  PREV (Previous) button on the Player for more than three seconds. The indication "Loc" in the Display window will flicker for a moment.

PREV



- Press the Number key "8" four times. You can now play the disc.

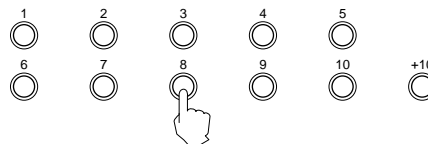

Canceling Read-Protect for a single viewing

Operation

- As above, hold down the  PREV (Previous) button on the Player for at least three seconds. The indication "Loc" in the Display window will flicker for a moment.

PREV



- Press the Number key "7" four times. You can now play the disc, but only until you press the  OPEN/CLOSE button for that disc, or until you play another disc. (Turning off the Player power does not lock the disc again.) This function is convenient when you want to play a disc, but you also want to restrict its use later.

GRAPHIC/DIGITAL AUDIO CDs

Playing CD Graphics/ digital audio CDs

Playing CD Graphics

Basic video CD-playing procedures apply although the pictures are still. A CD Graphics is identified by "CD-G" shown on the display.

Notes

- The following operations may distort the image on the screen.
 - Searching for starting point of music
 - Fast forwarding/reversing
 - Stop/pause
- If paused, the screen changes to blue in a few minutes. This is to prevent burn-in of the TV screen.

Playing digital audio CDs

Basic video CD-playing procedures apply to the reproduction of sound.

Note

- The display has no indicator to show disc type.

SPECIFICATIONS

Main specifications

XL-FV323TN

Model	Video CD player	
Playback disc	Video CD (with/without Playback Control function) CD Graphics Digital Audio CD	
Total harmonic distortion	0.01% (1kHz)	
S/N ratio	90 dB	
Frequency response	20Hz – 20kHz	
Input terminal	Microphone	2 mV (9.1 kΩ)
Output terminal	Line output	2.0 Vrms (full scale)
	Video output (composite)	1.0 Vp-p (75Ω)
Echoing	Digital echoing	
Power requirements	AC 115-127/220-240V ~ 50/60Hz Selectable with the voltage selector (except The People's Republic of China) AC 220V ~ 50Hz (The People's Republic of China)	
Power consumption		15 watts
	In standby mode	5 watts
Weight	5.2 Kg (11.5 lbs)	
Dimensions (W/H/D)	448 x 128 x 385 mm	
	17-11/16 x 5-1/16 x 15-3/16 inches	

Accessories

AC power cord	1
Audio video cord	1
Remote control unit (RM-SXFV555U)	1
Batteries (R6P(SUM-3)/AA(15F))	2
AC plug adaptor (except Hong Kong and China)	1

TROUBLESHOOTING

Troubleshooting

What appears to be a malfunction may not always be so. Please go through the following list before requesting service.

Symptom	Possible cause	Remedy
Power does not come on.	Power plug is disconnected from AC outlet.	Firmly connect the plug to AC outlet.
Remote control does not work.	Batteries are exhausted.	Replace the batteries with new ones.
	The tip of the remote control unit is not pointed at the receiving part of the player.	Use the remote control correctly.
No image is displayed on the monitor.	The video cord is not connected.	Firmly connect the cord.
	The TV is not set in video mode.	Set the TV in video mode.
	An incompatible disc is loaded.	Load a disc compatible with the player.
Playback does not start.	No disc is loaded.	Load a disc.
	Disc is loaded upside down.	Reload the disc with the label up.
Speaker does not produce sound.	Audio cord is not connected.	Firmly connect the cord.
	Operation of the external amplifier is incorrect.	Operate the amplifier correctly.
Sound is distorted or noise is generated. Image is garbled.	Disc is dirty.	Wipe the disc surface with a soft cloth.
	Connection is wrong.	Correctly connect cords. (See page 2.)
Sound is intermittent. Image is garbled.	Disk is dirty.	Wipe the disc surface with a soft cloth. (See page 1.)
	Disc is scratched.	Replace the disc with a new one.
	Disc is warped.	
Disc tray does not come out when  OPEN/CLOSE button is pressed.	Power plug is disconnected from the power outlet.	Firmly insert the plug into the outlet.
Operation is not possible.	Microcomputer malfunctions due to lightning or static electricity.	Turn the power off, then on again.

The malfunction may be caused by a device other than the player. Check other devices connected to the player.

We would like to thank you for purchasing one of our JVC products. Before connecting this unit to the wall outlet, read the instructions carefully to ensure that you obtain the best possible performance. If you have any questions, consult your JVC dealer.

Table of contents

GENERAL INFORMATION	1
Care and handling of compact discs	1
BEFORE USING FOR THE FIRST TIME	2
Basic connections	2
Connecting player to a TV or amplifier	
using the audio video cord	2
Video out select	2
Connecting the power cord	3
Installing batteries	3
Putting batteries in the remote control unit	3
OVERVIEW OF CONTROLS	4
Front panel	4
Remote control unit	5
BASIC OPERATIONS	6
Now you can play a variety of video CDs!!	6
Display window	6
Preparation for playing	6
Loading discs in the disc tray	6
Starting to play disc(s)	6
Specifying a desired disc	7
Using track number keys	7
Stopping play	7
Pausing play	7
Skipping to a desired disc	7
Auto search/Manual search	8
Slow-motion playback	8
Changing discs during playback	8
Using the remote control	9
Presetting the remote control to operate your own TV	9
Using the SHIFT button on the remote control unit	9
Preset code table	10
VARIOUS UNIQUE FUNCTIONS	11
Various functions can enhance your enjoyment	11
Display of operations status	11
Programming the track sequence you want	11
Canceling a programmed track	11
Clearing a program	11
Repeating tracks	12
Randomly playing tracks	12
Playing a multiplex sound CD	12
Viewing the VIDEO INTRO of a video CD	13
Programming during VIDEO INTRO	13
Viewing the highlights of a video CD	13
Playback with the Bookmark function	14
Marking segments for later viewing with the Bookmark function	
Using the BOOKMARK DIGEST button	14
Using the BOOKMARK SEARCH button	14
Canceling individual bookmarks	14
Canceling all bookmarks on individual discs	15
Using a microphone	15
Using a wired microphone	15
Adjusting music key	16
Adjusting echo effect	16
Vocal replace	16
OPERATION OF PLAYBACK CONTROL FUNCTION	17
Playing Video CDs with Playback Control function	17
Video CDs with Playback Control function	18
RESTRICTING USE OF YOUR DISCS	19
Locking a disc with the Read-Protect function	19
Locking a disc	19
Canceling Read-Protect	19
Canceling Read-Protect for a single viewing	19
GRAPHIC/DIGITAL AUDIO CDs	20
Playing CD Graphics/digital audio CDs	20
Playing CD Graphics	20
Playing digital audio CDs	20
SPECIFICATIONS	21
Main specifications	21
TROUBLESHOOTING	22
Troubleshooting	22

AC Power Line Instructions (not applicable for Europe, U.S.A., Canada, Australia and U.K.)

主 (AC) 電源線路說明 (不適用於歐洲、美國、加拿大、澳洲及英國型號)

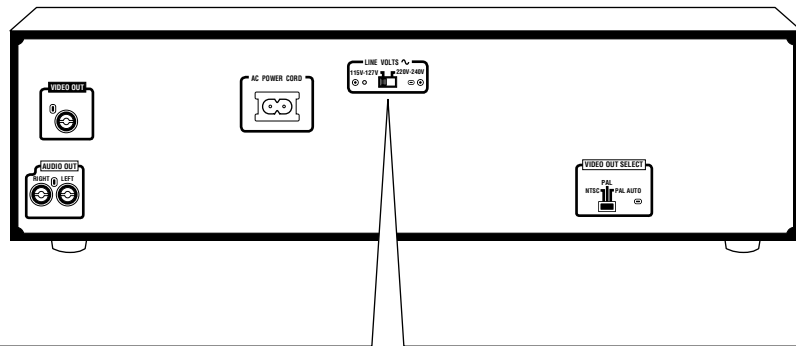

IMPORTANT

BEFORE PLUGGING IN, check that your AC power line voltage corresponds with the position of the voltage selector switch provided on the outside of this equipment. If different, reset the voltage selector switch, to prevent damage or risk of fire/electric shock.

有關主 (AC) 電源線路的重要事項

接插電源以前，務請檢查當地的主 (AC) 電源線路電壓是否和位於本機外面的電壓選擇開關設定的位置一致。如果不一致，即重新設定電壓選擇開關使符合當地電壓，以免損壞機器或引起火災 / 觸電的危險。